

SONY®

SONY 3-CCD Color Video Camera

DXC-C33/C33P



Product Information Manual

For use of authorised dealers

CONTENTS

1. PRODUCT CONCEPT	P. 2
2. APPLICATIONS	P. 3
3. KEY FEATURES	P. 4
4. MENU FUNCTION	P. 9
5. CAMERA CONNECTORS	P. 12
6. CONNECTOR PIN ASSIGNMENTS	P. 14
7. SPECIFICATIONS	P. 15
8. OPTIONAL ACCESSORIES	P. 18
9. SYSTEM EXAMPLES	P. 22
10. DIMENSIONS	P. 25
11. TECHNICAL APPENDIX	P. 26
12. Q & A	P. 30



DXC-C33/C33P

1. PRODUCT CONCEPT

High-performance, remote-head type camera

DXC-C33/C33P

- Small and light camera head unit
- C mount 3-CCD
- High picture quality
- DV output
- Digital signal processing



2. APPLICATIONS

Medical

Surgical microscopy
Slit lamp



Industrial inspection

Semiconductor
Tube



Special angle shooting

Sports
Production

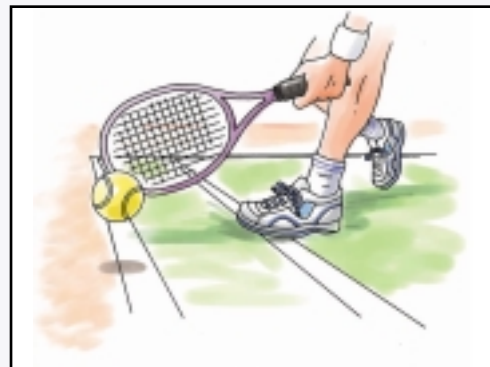

3. KEY FEATURES

Basic Specifications

Horizontal resolution	850 TV lines
Signal to Noise (S/N) ratio	NTSC: 62 dB (typical) PAL: 61 dB (typical)
Sensitivity	F8.0 at 2000 lux (3200 K)
Minimum illumination	4 lux (F2, GAIN: Hyper)
Output signal	DV, VBS, RGB/SYNC, Y/C
Dimensions (W x H x D)	CHU: 32 x 38 x 40 mm (1 5/16 x 1 1/2 x 1 5/8 inches) CCU: 200 x 88 x 242 mm (7 7/8 x 3 1/2 x 9 5/8 inches)
Power consumption	Max. 18 W
Mass	CHU: 48 g (1.7 oz) CCU: 2.5 kg (5 lb 8 oz)

Features

■ Small camera head

The DXC-C33/C33P can be installed in space-limited locations. The size of the camera head unit (CHU) is one of the smallest of all the 1/3 type 3-CCD cameras.



■ 10-bit DSP

The DXC-C33/C33P can capture superior pictures by adopting full Digital Signal Processing (DSP) of 10 bits.

■ High picture quality

The DXC-C33/C33P can clearly capture detailed object images. Using three 1/3 type CCDs, the camera can realize 2000 lux at F8, a S/N ratio of 62 dB (NTSC) or 61 dB (PAL) and achieve a horizontal resolution of 850 TV lines.



800 TV lines picture



850 TV lines picture

(Simulated picture)

■ Frame memory

Built-in frame memory can provide a remarkable freeze image and enhanced image sensitivity by the Long-Term exposure function. Images captured by the Long-Term exposure function can be output continuously.



Gain: 18 dB



Long exposure: 32 frames

■Partial Enhance

This function allows a particular color to be selected, and its hue, saturation and detail to be altered. In addition, the detail produced by the high resolution of the camera can be softened or emphasized in certain parts of the image with the Partial Enhance function.

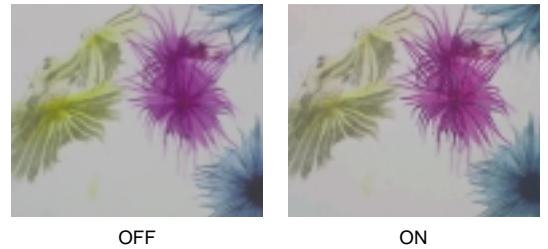

■User-friendly control panel

The front panel is very easy to use with good-sized switches that are smartly arranged.



■RS-232C interface

Easy control and operation of the camera by an external computer is possible. For details of the RS-232C protocol, please refer to the Control Protocol or contact your nearest Sony office.

■External synchronization (VBS Genlock, HD/VD)

The DXC camera can be synchronized with an external VBS signal from other equipment and includes a SC/H phase adjustment control. HD/VD sync signals also can be accepted. This is very useful in multiple camera operation and in connection with frame grabber boards.

■Two AE areas preset

AE (Automatic Exposure) function is very useful in determining the best area for incoming light metering. Users can select and set up two of the six different AE modes and can easily switch them on the front panel.

- The Multi mode measures the luminance level on the 9 divided windows and the center window is weighted compared to the others.
- In Manual mode, the user can freely define the light metering area.

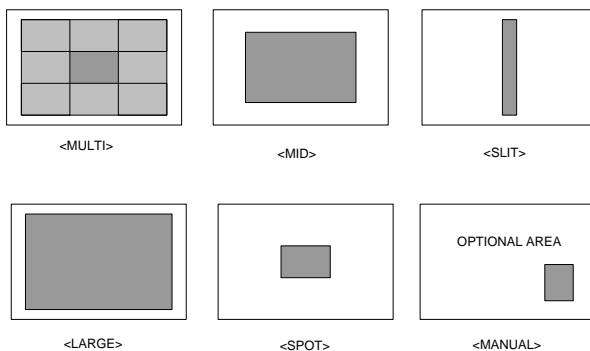

■Color shading compensation

The color shading compensation feature provides a uniformed color for images displayed on the screen.

3. KEY FEATURES

■ i.LINK™ (DV) out

DV (Digital Video) is the standard for consumer digital video. DV complies with the same IEEE1394 interface standard as the DFW Series. Thanks to data-compression technology, the transmission speed of DV is approximately 25 Mb/s. This figure is about 1/5 of the transmission speed of the DFW Series (no compression).

DV can be connected to a PC and various application software is available for DV. Users can therefore enjoy the high quality of DV compression with the excellent line-up of the DVCAM Series. The DXC-C33/C33P is equipped with a DV output terminal so that images can be recorded into an i.LINK interface-equipped VTR with no quality deterioration.

This feature is first to be introduced to small 3-CCD cameras.

* i.LINK stands for IEEE-1394-1995 standards and their revisions.

Note: Sony VAIO computers are checked with Sony DV products, but not with DVCAM, concerning the i.LINK interconnection. Some VAIO application software may not work with DVCAM.

CONCEPT - What is the benefit of the DVCAM for the DXC-C33/C33P?

Why was the DVCAM format Born?

The DVCAM format was developed to meet the following key demands:

- Digitization (trend from analog to digital)
- High-performance editing capabilities for professional use
- Full compatibility with the DV format

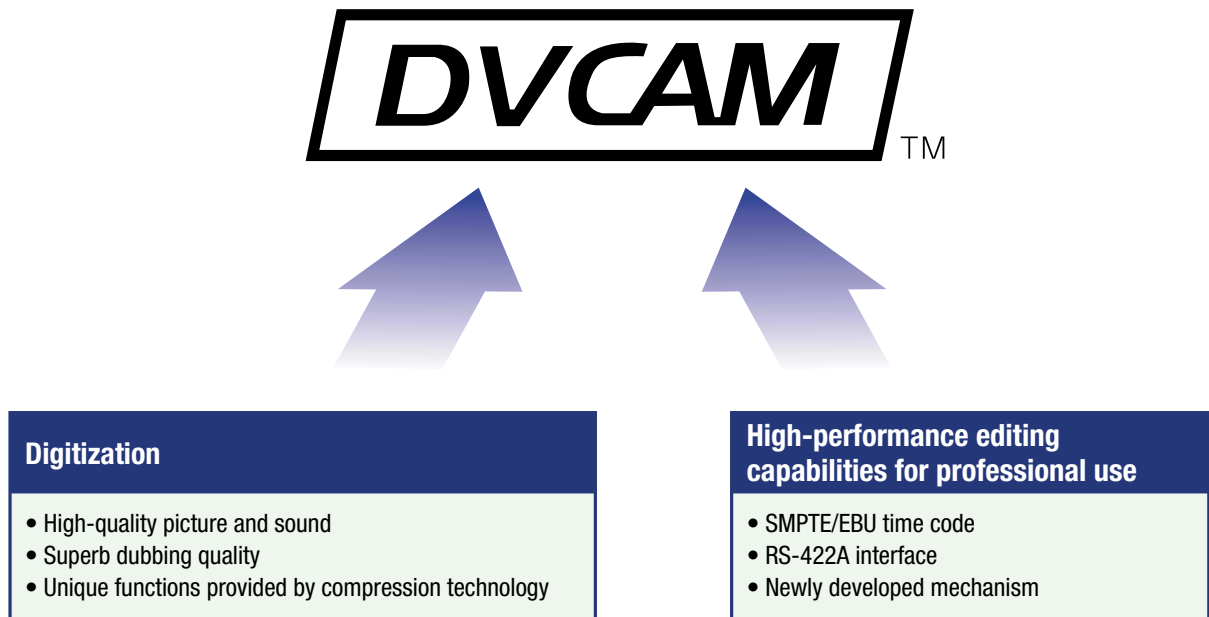

☛ The DVCAM format is optimized for professional editing, based on and maintaining cross play with the DV format.

The DVCAM & DV format

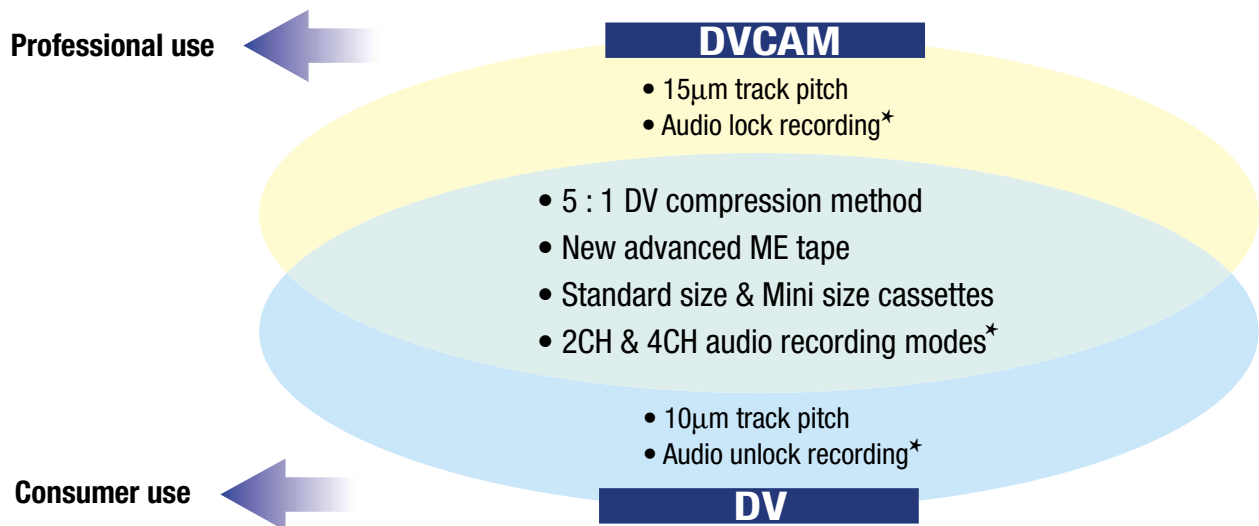

* Audio mode and audio channel are not available in the DXC-C33/C33P

The DVCAM format

The DVCAM format, which is available for the DXC-C33/C33P is, a professional development of the DV format. Specific advantages, shown below, mean it is optimised for professional editing.

The features and benefits of DVCAM format

◆ 5:1 DV compression

- Longer duration recording (max. 3 hours)
- High-speed data transfer capability

◆ Digital components

- High-quality picture
- Superb dubbing quality via QSDI & DV I/O

◆ Cassette memory

- Newly developed ClipLink system for top-of-the-range DVCAM VTRs
- Photo mode for mid-range DVCAM VTRs

3. KEY FEATURES

Comparison of 1/4-inch DVCAM, DV, and DVCPRO

Format	DVCAM	DV	DVCPRO
Compression method	5:1 DV compression	5:1 DV compression	5:1 DV compression
Tape material	ME (Metal Evaporated)	ME (Metal Evaporated)	MP
Cassette size	Standard / Mini	Standard / Mini	L / M
Track pitch	15µm	10µm (LP : 7.5µm)	18µm
Tape speed	28.193 mm/s	18.812 mm/s	33.820 mm/s
Compatibility cassette with Home DV	Full Compatibility	—	Playback of Mini (Adaptor required) Playback of Standard cassette (Menu switching required)
Audio mode	Lock mode*	Unlock mode	Lock mode
Audio channel	16bit 2ch / 12bit 4ch*	16bit 2ch / 12bit 4ch	16bit 2ch
Compatibility with i.LINK (DV) terminal	O	O	X (compatibility with other DVCPRO)
Max. duration recording time Max. cassette size	184 min. (Max)	270 min. (Max) LP: 405 min. (Max)	184 min. (Max)
Max. duration recording time Min. cassette size	40 min. (Max)	80 min. (Max) LP: 120 min. (Max)	66 min. (Max)
Linear track	X	X	CTL / CUE track

* Audio mode and Audio channel are not available in the DXC-C33/C33P.



4. MENU FUNCTION

Configuration

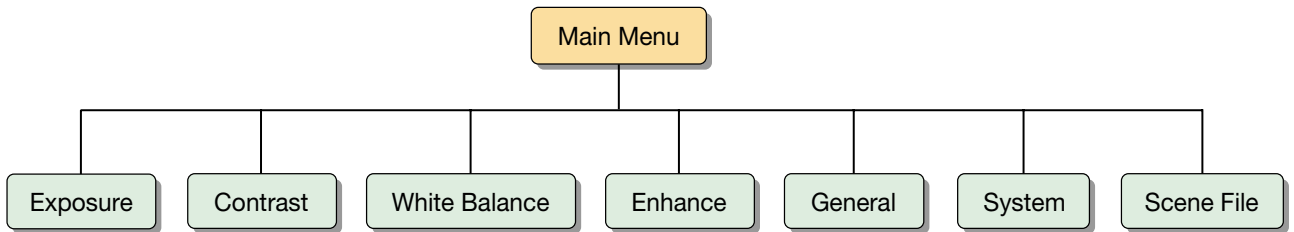

Main Menu

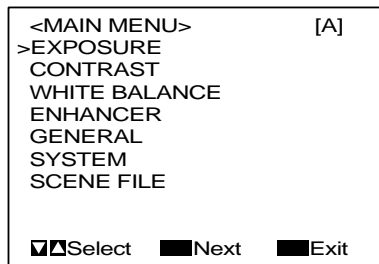

Sub Menu

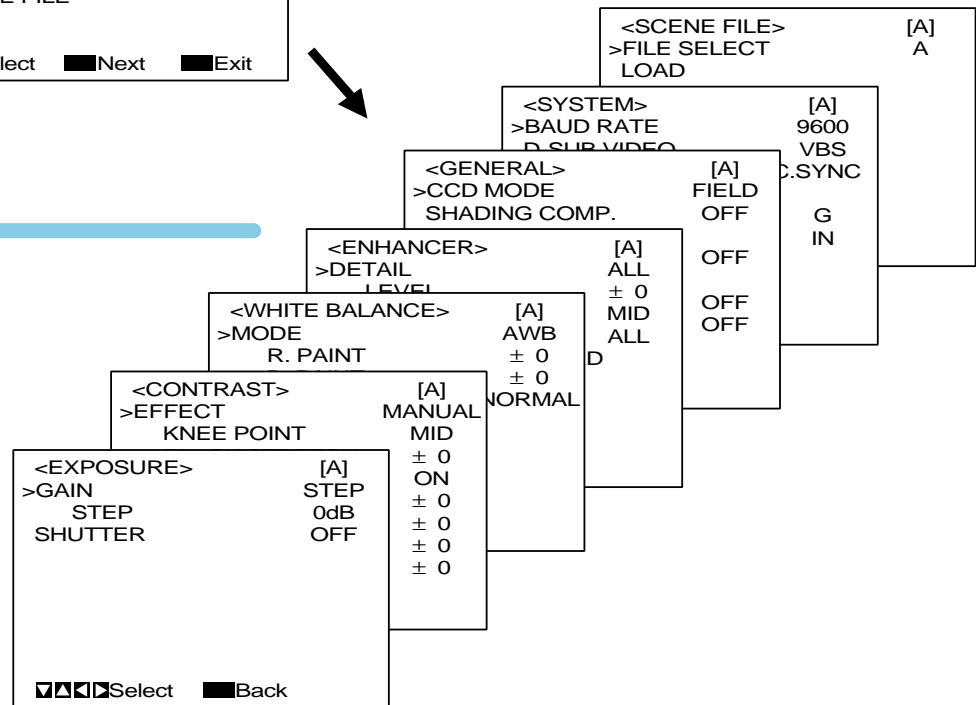

Setting Items in the Menu

<EXPOSURE>	[A]
>GAIN	STEP
STEP	0dB
SHUTTER	OFF

- GAIN Adjusts the video gain
- STEP Sets the gain level
- SHUTTER Sets the electronic shutter modes
- SPEED Sets the shutter speed
- AE LEVEL Finely adjusts the focusing point of AE adjustment
- AE AREA 1 Sets the AE window in AGC or CCD IRIS or auto iris adjustment mode
- AE AREA 2
- AE SPEED Sets AE focusing speed in AGC or CCD IRIS or control mode
- AE DETECT Sets the detection method of the luminance level of the selected AE window

<CONTRAST>	[A]
>EFFECT	MANUAL
KNEE POINT	MID
BLACK STRETCH	± 0
GAMMA	ON
LEVEL	± 0
MASTER PEDESTAL	± 0
R. PEDESTAL	± 0
B. PEDESTAL	± 0

- EFFECT Adjusts the picture contrast in accordance with the incident luminance level
- KNEE POINT Sets the Knee point
- BLACK STRETCH Adjusts the luminance of dark portions on the screen
- GAMMA Activates gamma compensation
- LEVEL Adjusts the gamma level
- MASTER PEDESTAL Sets the pedestal level of the output signal
- R./B. PEDESTAL Finely adjusts the pedestal level

<WHITE BALANCE>	[A]
>MODE	AWB
R. PAINT	± 0
B. PAINT	± 0
AREA	NORMAL

- MODE Selects white balance modes
- R./B. PAINT or R./B. GAIN Finely adjusts the white balance (AWB, ATW) or manual white balance (MANU)

<ENHANCER>	[A]
>DETAIL	ALL
LEVEL	± 0
FREQUENCY	MID
LINEAR MATRIX	ALL
MODE	STANDARD
Select Back	

- DETAIL Enables or disables adjustment of sharpness of the image outline
- LEVEL Adjusts the sharpness of the image outline
- FREQUENCY Adjusts the sharpness of the detailed image outline
- LINEAR MATRIX Enables or disables processing of a color matrix
- MODE Finely adjusts the color tone
- TARGET COLOR Specifies the color for DETAIL or LINEAR MATRIX adjustments

<GENERAL>	[A]
>CCD MODE	FIELD
SHADING COMP.	OFF
FS/TRIG IN	OFF
NEGA	OFF
FLICKER CANCELLER	OFF
Select Back	

- CCD MODE Selects the CCD read-out mode
- SHADING COMP. Eliminates color at the top and bottom of the screen
- LEVEL Adjusts the SHADING COMP. level
- FS/TRIG IN Selects the input signal from the FS/TRIG IN connector
- NEGA Reverses the output image to negative
- FLICKER CANCELLER Reduces flicker when SHUTTER is set to CCD IRIS or OFF

<SYSTEM>	[A]
>BAUD RATE	9600
D-SUB VIDEO	VBS
D-SUB SYNC	C.SYNC
RGB SYNC	G
EXT SYNC	IN
Select Back	

- BAUD RATE Selects the baud rate
- D-SUB SYNC Switches the sync signal from the D-sub 9-pin
- RGB SYNC Adds a sync signal to the RGB output
- EXT SYNC Switches the input and output of the EXT SYNC (HD, VD/SYNC) jack and selects the output signal
- H.PHASE Adjusts the horizontal phase when using the camera with the external sync signal
- SC.PHASE ROUGH Roughly adjusts the subcarrier phase when using the camera with the external sync signal
- SC.PHASE FINE Finely adjusts the subcarrier phase

<SCENE FILE>	[A]
>FILE SELECT	A
LOAD	
Select Back	

- FILE SELECT Selects the file into which you store the setting
- LOAD Selects the type of setting to be stored, and loads it

5. CAMERA CONNECTORS

Front Panel

• **LEFT/FILE SELECT button**

While the menu is displayed;
Decreases the setting value or changes the setting.
Also used for an AE window setting, etc.
While the normal screen is displayed;
Switches the user preset file between A and B

• **FREEZE button and indicator**

Pressing this button stores an image in the built-in frame memory and outputs it as a freeze picture. When the freeze picture mode is activated, the indicator lights.

• **(Power) switch and indicator**

The indicator lights up in green when the power is on.

Note: the CHU must be connected to the CCU by the camera cable before switching on or off.

• **CAMERA connector (20-pin)**

Connects to the CHU via the CCMC-20P05/10/30 camera cable.

• **BARS (color bars output) button**

Displays/hides color bars.

• **DOWN button**

Moves the menu cursor downward.
Also used for an AE window setting, etc.

• **UP/BLACK (black balance) button**

While the menu is displayed;
Moves the menu cursor upward.
Also used for an AE window setting, etc.
While the normal screen is displayed;
Activates the automatic black balance adjustment.

• **MENU button**

Displays/hides the menu on the monitor screen.
When a setting menu is displayed, press this button to return to the MAIN menu.

• **ENTER button**

Selects a setting menu. Also used for an AE window setting, etc.

• **AE AREA SELECT button**

Selects the AE window set in the menu. Each press of the button selects the AE AREA 1 or the AE AREA 2.

Note: The button functions only when GAIN is set to AGC or SHUTTER is set to CCD-IRIS.

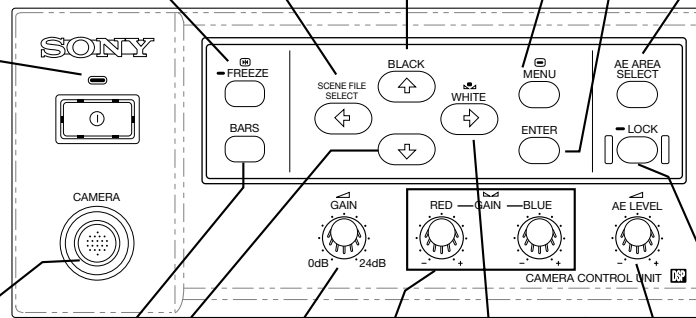

• **LOCK button and indicator**

Locks all buttons and knobs on the CCU except for power switch (The indicator lights).

Note: The lock mode retains after the unit is switched off.

• **GAIN control**

Adjusts the gain level in the range from 0 to 24 dB.

• **RIGHT/WHITE (white balance) button**

While the menu is displayed;
Increases the setting value or changes the setting. Also used for an AE window setting, etc.

While the normal screen is displayed;
Activates the automatic white balance adjustment when MODE is set to AWB in the WHITE BALANCE menu.

• **GAIN RED/BLUE controls**

Controls fine adjustment of white balance when AWB or ATW mode is selected. Also controls the red and blue gain when adjusting the white balance manually.

• **AE LEVEL control**

Adjusts the auto exposure convergence level, when the camera is set to AGC or CCD-IRIS mode.
Luminance level is precisely adjusted in KNOB mode.

Rear Panel

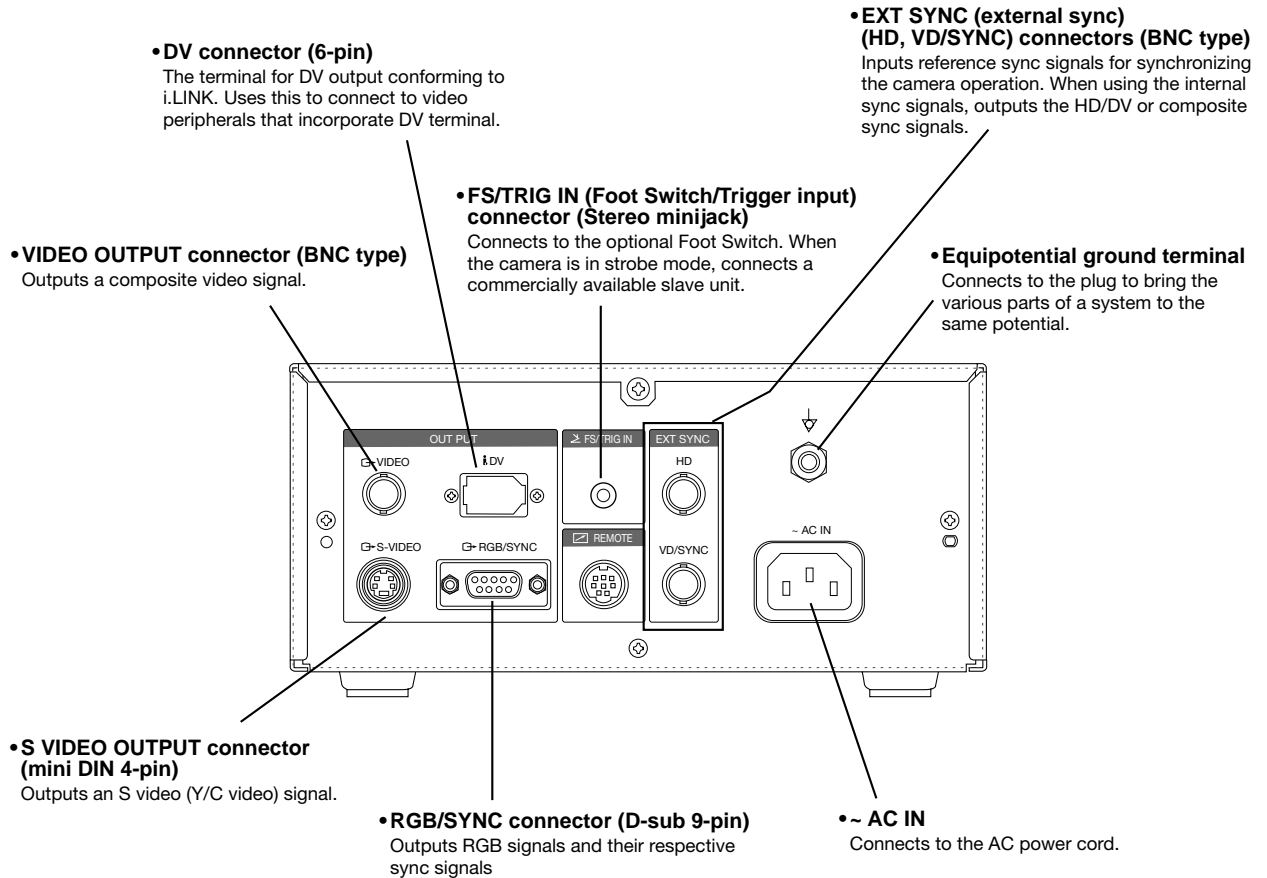

6. CONNECTOR PIN ASSIGNMENT

9-Pin D-sub Connector

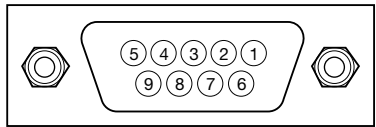

MENU	D-sub VIDEO: VBS D-sub SYNC: C.SYNC	D-sub VIDEO: VBS D-sub SYNC: WEN	D-sub VIDEO: Y/C D-sub SYNC: C.SYNC	D-sub VIDEO: Y/C D-sub SYNC: WEN
1	VBS OUT (G)	VBS OUT (G)	Y/C OUT (G)	Y/C OUT (G)
2	RGB OUT (G)	RGB OUT (G)	RGB OUT (G)	RGB OUT (G)
3	R OUT (X)	R OUT (X)	R OUT (X)	R OUT (X)
4	G OUT (X)	G OUT (X)	G OUT (X)	G OUT (X)
5	B OUT (X)	B OUT (X)	B OUT (X)	B OUT (X)
6	VBS OUT (X)	VBS OUT (X)	Y OUT (X)	Y OUT (X)
7	C.SYNC OUT (X)	WEN OUT (X)	C.SYNC OUT (X)	WEN OUT (X)
8	C.SYNC OUT (G)	WEN OUT (G)	C.SYNC OUT (G)	WEN OUT (G)
9	(X)	(X)	C OUT (X)	C OUT (X)

Mini Din 8-Pin Connector

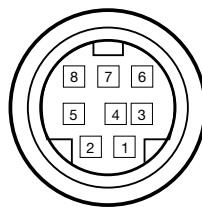

1	INTER CONNECT
2	INTER CONNECT
3	DATA OUT
4	DC OUT (G)
5	DATA IN
6	NC
7	DC OUT (+)
8	NC

7. SPECIFICATIONS

Image System/Optical System

Image device	1/3 type IT (Internal Transfer) CCD
Effective picture elements (H x V)	NTSC: 768 x 494 PAL: 752 x 582
Sensing area (H x V)	4.8 x 3.6 mm
Unit cell (H x V)	NTSC: 6.35 x 7.40 μ m PAL: 6.50 x 6.25 μ m
Mount	C mount

Video System

Synchronization system	Internal or External with VBS or HD/VD
Signal format	DXC-C33: NTSC standard format (EIA standard) DXC-C33P: PAL standard format (CCIR standard)
Scanning system	DXC-C33: 2 : 1 interlaced, 525 lines DXC-C33P: 2 : 1 interlaced, 625 lines
Scanning frequency	DXC-C33: 15.734 kHz DXC-C33P: 15.625 kHz

Functions/Performance

Horizontal resolution	850 TV lines
Sensitivity	F8.0 at 2000 lux (3200 K)
Minimum illumination	4 lux (F2, GAIN: HYPER)
S/N ratio	DXC-C33: 62 dB (typical) DXC-C33P: 61 dB (typical)
Gain control	STEP/AGC/HYPER selectable STEP: 0 to 24 dB by 1 dB step AGC: 0 to 24 dB (Limit value: 6 dB, 12 dB, 18 dB, 24 dB (selectable)) HYPER: 30 dB
Electronic shutter	8.0 to 1/100,000 s
Lens	Manual Iris
AE area	Multi/Large/Medium/Spot/Slit/Manual (selectable)

7. SPECIFICATIONS

AE level	Variable
AE speed	Fast/Mid/Slow (selectable)
AE detect	Average/Peak (selectable)
Contrast effect	Manual/DynaLatitude/DCC+ (selectable)
Gamma	ON/OFF (Variable at ON)
Pedestal	Master and R/B Manual (adjustable)
Black balance	ABB
White balance	AWB/ATW NORMAL/ATW WIDE/MANUAL/3200 K/5600 K (selectable) AWB or ATW R/B Paint, MANUAL R/B Gain
Detail level	ALL/TARGET/OFF (Variable at ALL or TARGET)
Detail frequency	HIGH/MID/LOW (selectable)
Linear matrix	ALL/TARGET/OFF
CCD integration mode	FIELD/FRAME (selectable)
Shading compensation	OFF/ON (Manual control)
Baud rate	Phase control H/SC phase control 19200/9600/4800/2400/1200 (selectable)
User file	A/B (switchable) (Two pattern memories)
Scene file	STANDARD/MICROSCOPE/FULL AUTO/STROBE/FILE A or B

Input/Output

Video output signals	i.LINK (DV): IEEE1394 Based VBS: 1.0 Vp-p, 75 Ω , sync negative RGB: 0.7 Vp-p, 75 Ω , sync (switchable) SYNC: 2 Vp-p, 75 Ω Y: 1.0 Vp-p, 75 Ω C: NTSC 0.286 Vp-p, 75 Ω , without sync PAL 0.3 Vp-p, 75 Ω , without sync
External sync input	VBS/BS, HD/VD
Input/Output connectors	DV OUT (6-pin jack) RGB/SYNC (9-pin D-sub) VIDEO OUT (BNC) S-VIDEO (4-pin mini DIN) FS/TRIG IN (Stereo Mini jack) REMOTE (8-pin mini DIN) AC Inlet Camera (20-pin)

General

Power supply	100 to 240 V AC, 50/60 Hz
Operation temperature	-5 to 45°C (23 to 113°F)
Storage temperature	-20 to 60°C (-4 to 140°F)
Operating humidity	20% to 80%
Storage humidity	20% to 90%
Power consumption	Max. 18 W
Dimensions (W x H x D)	CHU: 32 x 38 x 40 mm (1 ⁵ / ₁₆ x 1 ¹ / ₂ x 1 ⁵ / ₈ inches) CCU: 200 x 88 x 242 mm (7 ⁷ / ₈ x 3 ¹ / ₂ x 9 ⁵ / ₈ inches)
Weight	CHU: 48 g (1.7 oz) CCU: 2.5 kg (5 lb 8 oz)
Supplied accessories	Tripod adaptor AC power cable Lens cap Panel sheet for RM-C950 Operation instruction manual

8. OPTIONAL ACCESSORIES

Cable

CCMC-20P05/20P10/20P30



Features

- Specially designed camera cable for DXC-C33/C33P
- 20-pin Multi Cable (5/10/30 m) for connecting CHU to CCU

DVCAM™ Recorder

DSR-11



Features

- Employs the DVCAM format to offer excellent picture and sound quality. Also compatible with DV format recording and playback (SP mode only)
- The compact, unique design enables both horizontal and vertical installation
- Compatible with both Standard and Mini cassette sizes
- Compatible with both NTSC and PAL recording/playback
- i.LINK (DV) interface allows a single cable connection to simultaneously transfer audio, video and command signals with virtually no quality loss
- Wireless Remote Commander RMT-DS11 supplied
- Dimensions (W x H x D): 180 x 69 x 258.4 mm
(7 1/8 x 2 3/4 x 10 1/4 inches),
excluding projections
- Mass: 2.8 kg (6 lb 2 oz)
- Power consumption: 15 W

DVCAM Recorder**DSR-20/20P/20MD/20MDP****Features**

- Employs the DVCAM format to offer excellent picture and sound quality. Also compatible with DV-format recording and playback (SP mode only)
- Compatible with both Standard and Mini cassette sizes
- i.LINK (DV) interface allows a single cable connection to simultaneously transfer audio, video and command signals with virtually no quality loss
- LANC, RS-232C, and Control S interfaces are equipped for remote control operations
- Equipped with both AC and DC input
- Medical safety regulation approved (DSR-20MD/20MDP only)
- Wireless Remote Commander RMT-DS20 supplied
- Dimensions (W x H x D): Approx. 212 x 98 x 395 mm
(8 ³/₈ x 3 ⁷/₈ x 15 ⁵/₈ inches)
including external projections
- Mass: Approx. 5.0 kg (11 lb)
- Power requirements: AC: 120 V, 50/60 Hz DC: 12 V
- Power consumption: AC: 28 W DC: 2.0 A

Portable editing recorder**DSR-70A/70AP****Features**

- Superb picture quality of the DVCAM format
- Playback capability of DV (SP), DVCAM and DVCPR0-recorded tapes*1 (without a mechanical adaptor)
- Compact, all-in-one package including a 6.4-inch VGA LCD monitor, a full cut-editing controller with a Jog/Shuttle dial and an audio speaker
- Long recording time: up to 184 minutes with a standard-size cassette and 40 minutes with a mini-size cassette
- Sequential recording for up to 6 hours
- High-speed picture search over a range of 32 times normal speed, in both forward and reverse
- Linear editing by connecting two DSR-70A units
- Closed-caption function
- Parallel-run recording
- Two-way power supply system (AC/DC)

*1: SDTI (QSDI) and i.LINK (DV) interfaces do not support DVCPR0 playback.

Cable

VMC-IL4615/IL4635/IL6615



Features

- i.LINK Cable (1.5/3.5 m) for connecting DXC-C33/C33P to DVCAM Series

Cable

CCMC-9DS



Features

- CCMC-9DS: 5 m, 9-pin D-sub <--> BNCs (R/G/B/SYNC) and DIN 4-pin (Y/C)

Cable

CCXC-9DB/9DD



Features

- 5 m, 9-pin D-sub <--> 9-pin D-sub

Lenses**VCL-08WM/16WM/25WM****Features**

- 1/3 type C mount
- Focal length: 8 mm (VCL-08WM) / 16 mm (VCL-16WM) / 25 mm (VCL-25WM)
- F number: 1 : 2.2
- Iris: F2.2 to F16

Remote control unit**RM-C950****Features**

- Full remote control of the camera functions
- Easy control of functions such as Gain, Detail, Master Pedestal and Red and Blue Gain by turning knobs on the unit
- Power is supplied through the DXC-C33/C33P connected to the camera adaptor
- Original sheet panel is supplied
- Dimensions (W x H x D): 212 x 41 x 132 mm
- Mass: Approx. 400 g
- Power requirements: DC 12 V

9. SYSTEM EXAMPLES

Basic

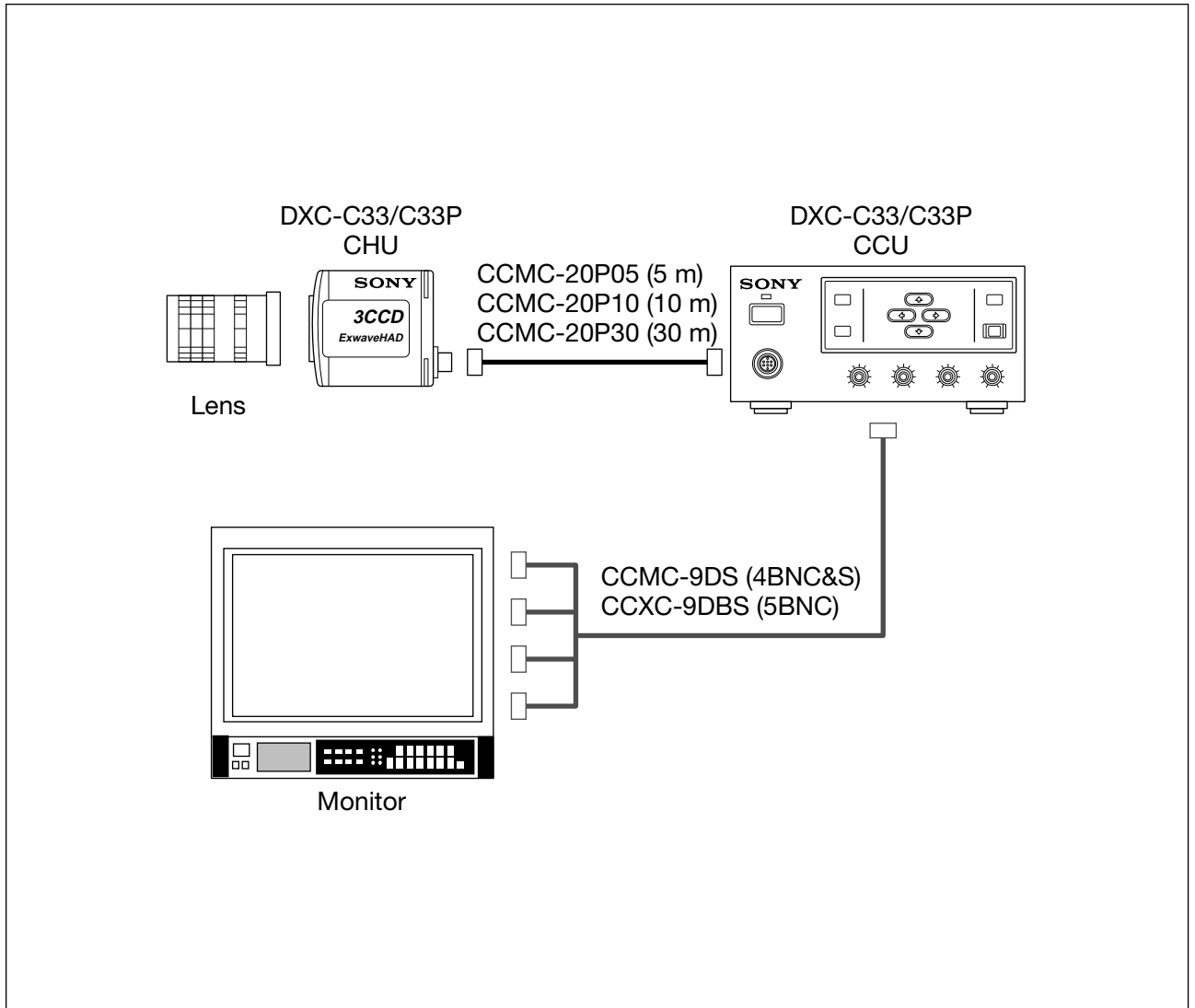

Microscope

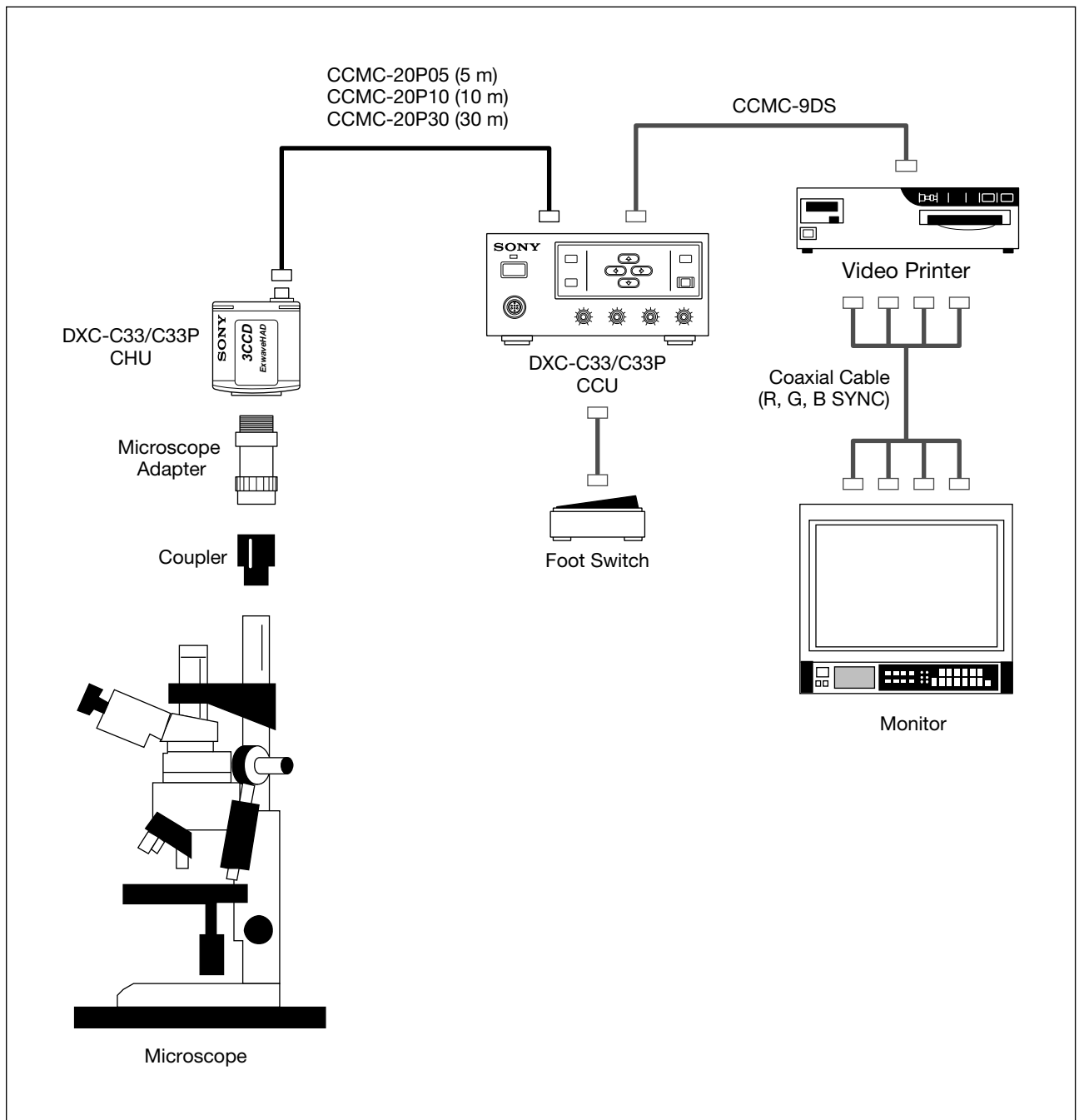

Note: 'Sync on Green' function should be equipped with peripherals. Please set the 'SYNC' on the 'SYSTEM' sub menu to 'G' or 'RGB' when using the Long-Term exposure function because it is necessary to output the WEN pulse from the connector for sync.

Surgical Microscope

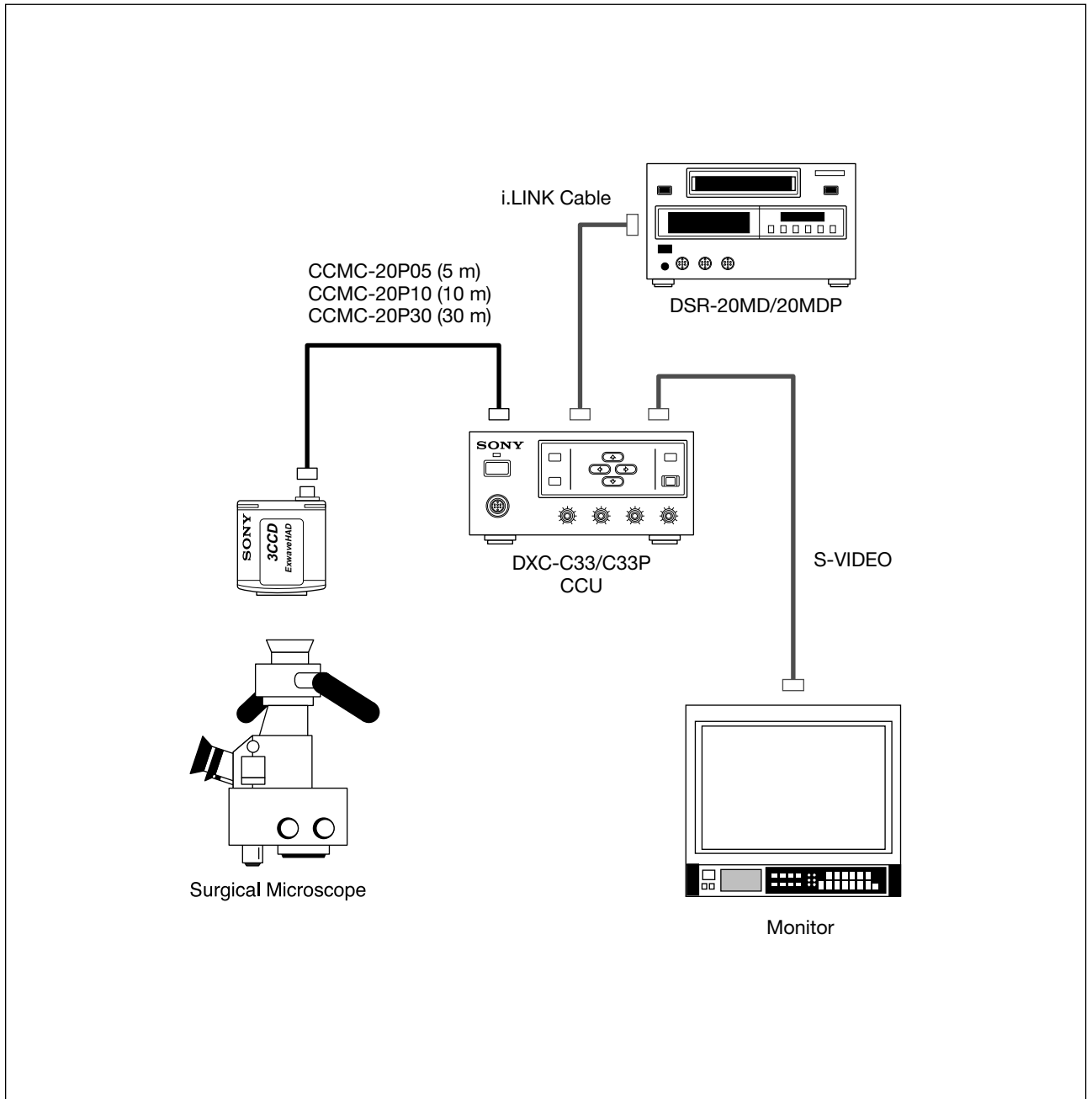

10. DIMENSIONS

DXC-C33/C33P CCU

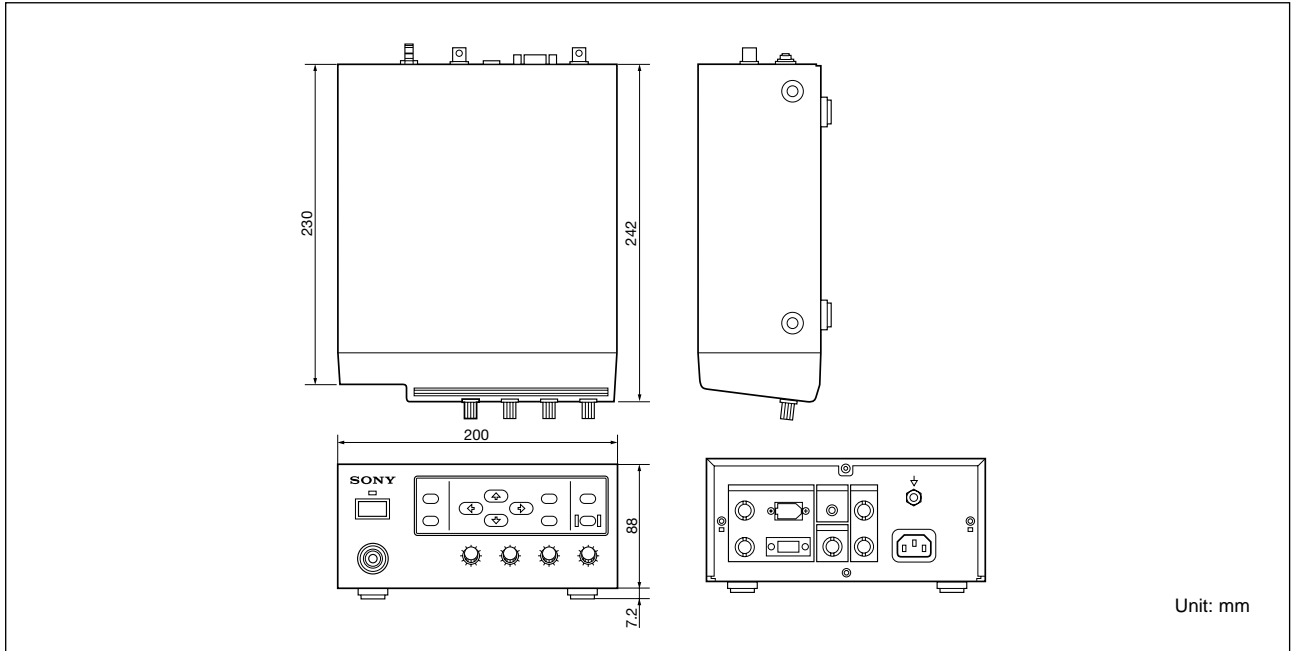

DXC-C33/C33P CHU

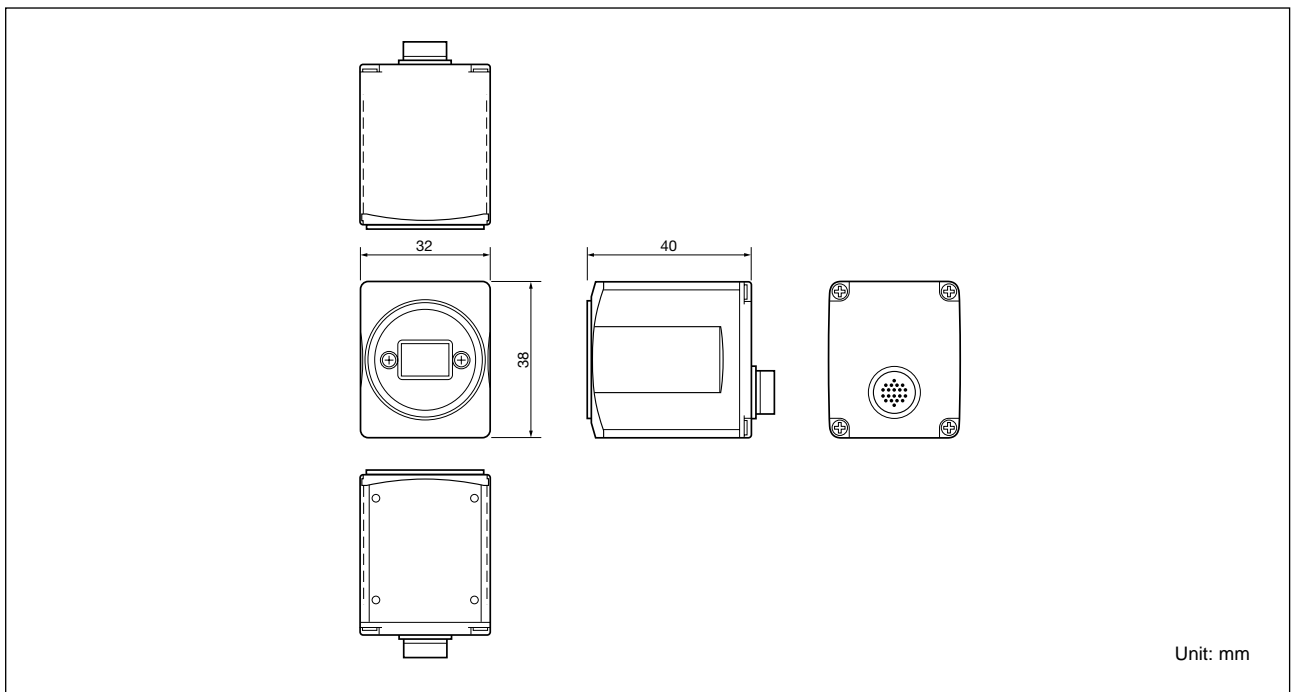

11. TECHNICAL APPENDIX

DSP

■ DynaLatitude™

- The DynaLatitude processing function enables you to adjust the contrast of each pixel according to the luminance signal level of each picture element.
- The DynaLatitude function minimizes video level distortion based on video signal histograms in order to utilize the limited dynamic range of the standard video signal.
- If there is a dark section and bright section in one image (i.e. shade and sunshine), then both parts will often look vague. The DynaLatitude function allows you to adjust the sharpness of both sections.
- Even when lighting is favorable, more luminance levels will be allocated to the subject, creating a clearer, more detailed image.

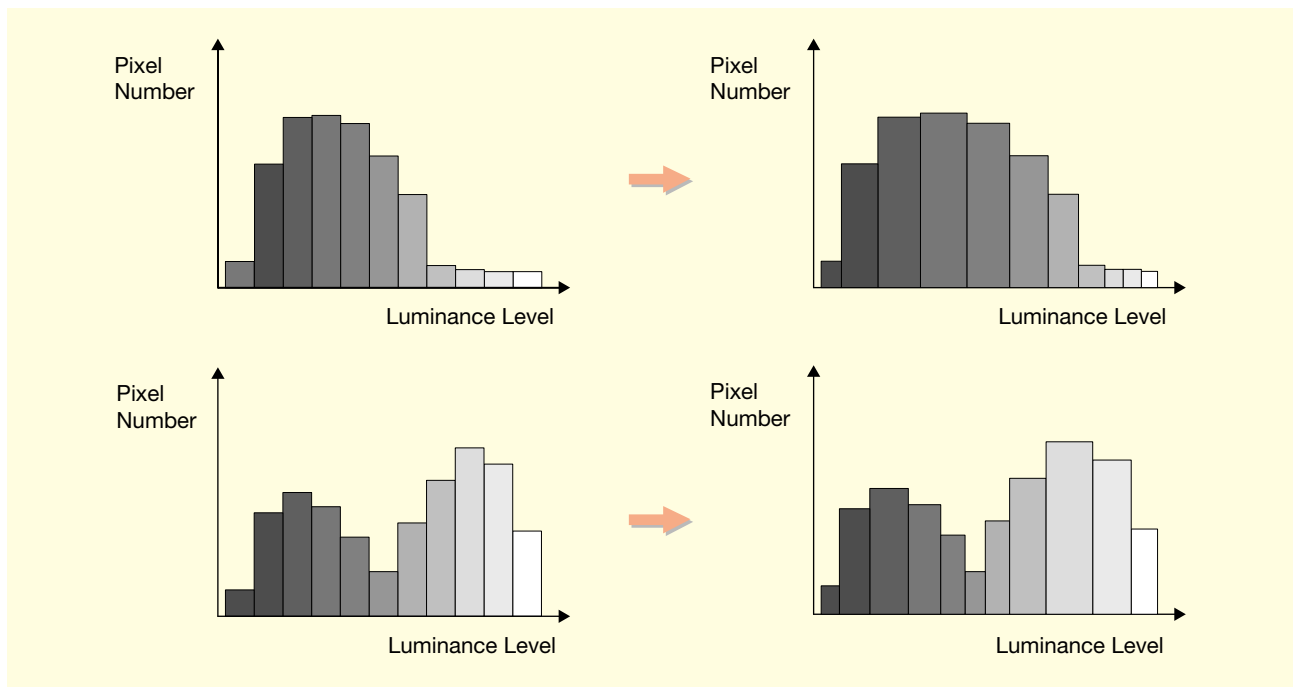
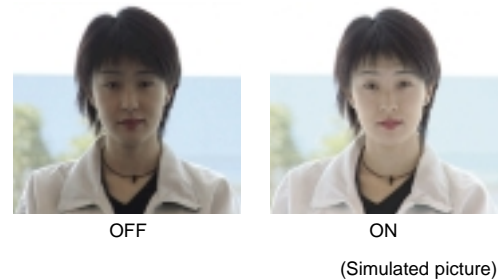

■ DCC+ process

- The DCC+ (Dynamic Contrast Control Plus) process manages video signal data at three levels - brightness, hue and saturation. The result is an image with suitable Knee correction and without hue distortion.

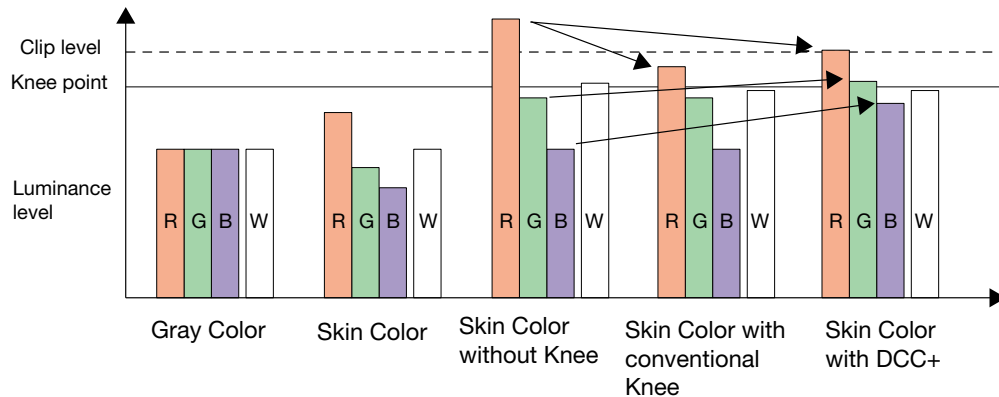

■ Knee and Black Stretch

- By adjusting the Knee, a Knee point and Knee slope are set so that the highlighted areas of the picture can be clearly reproduced.
- Contrast in the dark area of the image can be variably adjusted using the Black Stretch function for a clear view of specific details.

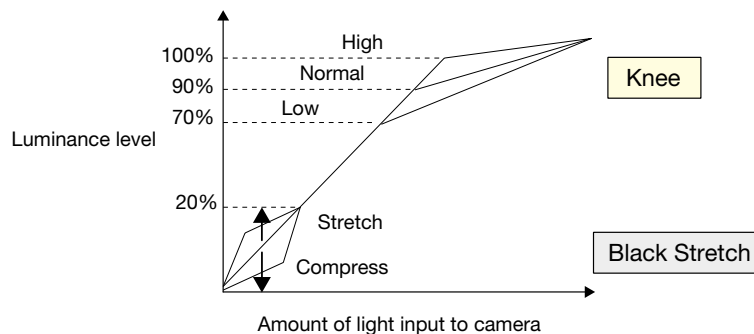

Electronic Shutter function

- The variable electronic shutter built into the CCD imager enables the DXC-C33/C33P to capture clear images of moving objects. The shutter speed can be manually selected from a wide range of speeds (up to 1/100000).
- The Flickerless mode allows you to obtain flickerless images even in fluorescent lighting conditions.
- The Clearscan™ mode reduces the horizontal bands that appear in computer displays when shooting the display with a conventional video camera.

<Shutter-speed calculation in Clearscan mode>
 Example: When the value is set to 250 H
 (NTSC) 250 63.56 us (1 H) + 34.78 us (constant)
 = 15924.78 us
 = 1/62.8 s
 (PAL) 250 64 us (1 H) + 35.6 us (constant)
 = 16035.6 us
 = 1/62.4 s

Long Term Exposure function

- When shooting very dark objects or objects in dark lighting conditions, you can manually set the shutter speed to 1/60 of a second or more to allow extra light to accumulate on the CCD sensors, resulting in enhanced sensitivity.
- By Synchronizing the WEN pulse of the camera signal output with an external memory unit such as a frame grabber unit/board, it is possible to obtain a still video picture.

<Shutter-speed calculation in LTE mode>	
Example: When the value is set to 5 FRM	
(NTSC)	5 1/30 = 0.167 s
(PAL)	5 1/25 = 0.2 s

Versatile white balance

The DXC-C33/C33P has six types of white balance control modes.

a) AWB

The White balance is updated by pushing the WHITE button on the front panel.

b) ATW Normal and ATW Wide

ATW automatically adjusts the white balance in response to varying light conditions. The DXC-C33/C33P has two ATW modes. Normal mode is effective for a color temperature range of 2600K to 8000K, and Wide mode adopts wider range of 2400K to 9000K. The Wide mode is useful under sodium lamps such as those used in traffic surveillance. In addition, the DXC-C33/C33P has functions that make the area and response speed of ATW adjustable, as with the AE function.

c) Manual

The white balance can be adjusted manually according to requirements using the Red and Blue Gain Level.

d) Preset 3200K/5600K

There are two preset white balance modes: one at a color temperature of 3200K and one at 5600K. The 3200K mode is recommended when the camera is used indoors. The 5600K mode is recommended when the camera is used outdoors during the daytime.

Functions using WEN pulse — Output signal to external frame memory

The DXC-C33/C33P puts out a WEN pulse that enables the external frame memory to minutely store the video signal output. The timing of the external frame memory can be locked by the HD/VD signal or the sync signal of the DXC-C33/C33P so that the write-start timing of the external frame memory can be precisely controlled. In short, the output pulse is effective for the video signal just after the end of this pulse. The WEN pulse is useful to connect a frame grabber board or video printer for the Strobe and Long-Term Exposure functions. Using the WEN pulse, users can capture full-frame still images easily.

Signal specifications of the output pulse

- Output terminal: The 7th pin of the D-sub connector
- Output signal: The polarity of the pulse is switchable, and the signal is 75 ohms, unbalanced.
- Pulse width: 1V(one field)

The DXC-C33/C33P has three pulse modes: WEN-NORM, Strobe and Long term exposure.

1. WEN-NORM mode

The WEN pulse is continuously puts out a high signal in an even field, a low signal in an odd field or vice versa (see diagram). This means that the output pulse is a field index pulse.

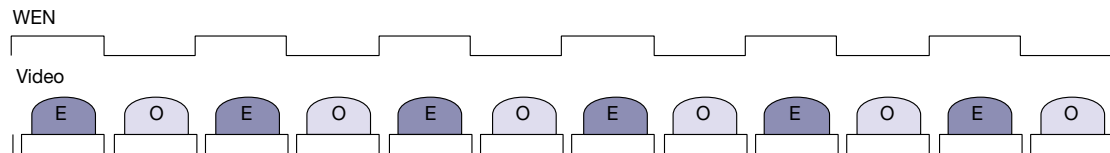

2. Strobe mode

When the DXC-C33/C33P is set to the Strobe mode, the type of WEN pulse used is WEN-ODD only (see diagram of Strobe function). The WEN pulse is useful when used as a trigger for external frame memory to precisely capture full frame.

3. Long-Term exposure mode (WEN-EVEN mode and polarity rising edge)

During the Long-Term exposure mode, the video signal is output, as shown in the diagram below and the WEN pulse is output in one the field before the valid video field outputs (see diagram of Strobe function). The shutter speed must be set before the mode is selected.

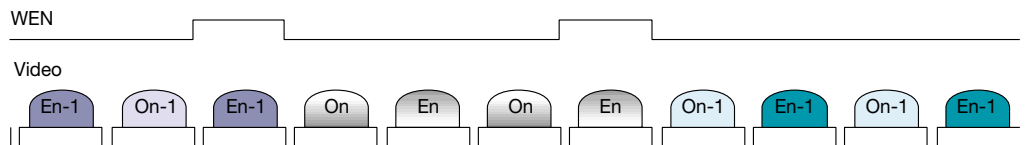

In case of 2 FRM, shutter speed

Note: It is impossible to use both the Strobe mode and the Long-Term exposure mode at the same time.

12. Q & A

Q.1

Is it possible to use any cables except the CCMC-20P05/10/30 to connect the CCU with the CHU?

A: No

Q.2

How many pins does the DV terminal of the DXC-C33/C33P have?

A: 6 pins. Please use a 6-4 pin/6-6 pin cable to connect DV equipment.

Q.3

Is it possible to output component signals from the DXC-C33/C33P?

A: No.

Q.4

Will camera settings change if you move knob switches when the camera is locked?

A: No. Knob switches don't work when the camera is locked. It's not until the lock is released that the camera settings change to the knob positions.

Q.5

Is it possible to use auto iris control lens?

A: No.

Q.6

Is it possible to adjust the flange focal length of a lens?

A: No.

Q.7

What is the dynamic range of the DXC-C33/C33P?

A: The dynamic range is about 300%. The DynaLatitude function is very useful when shooting an image with both dark and bright areas in a single picture.

Q.8

Is the RS-232C protocol open to the public?

A: Yes. Contact the nearest Sony sales office for more details.

Q.9

Can lenses other than the optional lenses be used for the DXC-C33/C33P?

A: There are limitations to the type of C-mount lenses used with the DXC-C33/C33P. The lens must not project more than 4.3 mm (3/16 inches) from the lens mount surface. Even if lenses meet this requirement, color aberration may appear because most C mount lenses on the market are designed for one CCD, not for 3-CCD, cameras.

Distance from lens mount surface must not be more than 4.3 mm

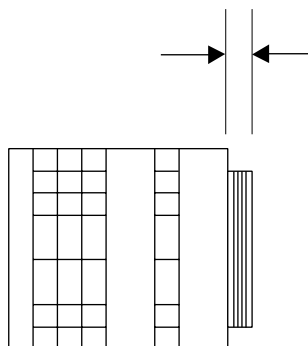

3. Key Features
