

### OVERALL DIMENSIONS

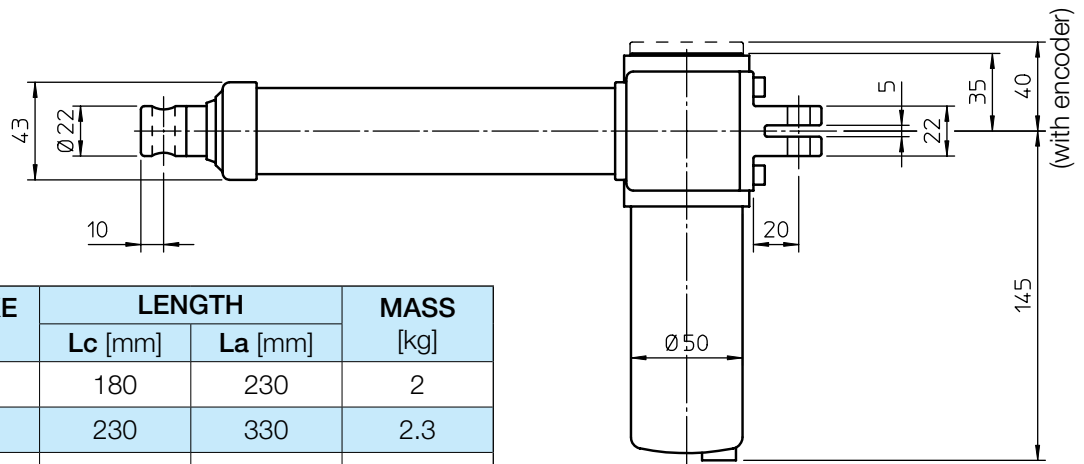
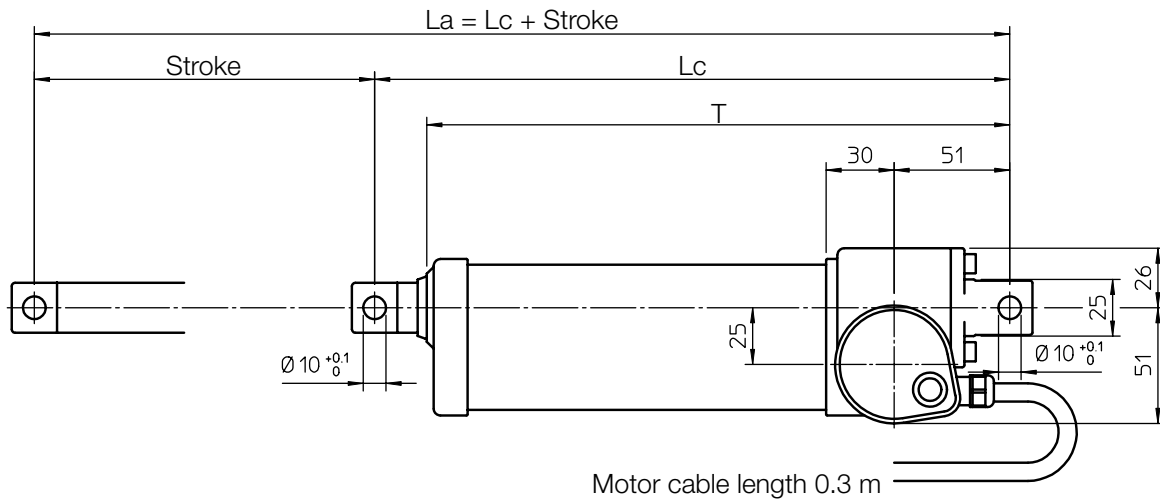

STROKE CODE	STROKE [mm]	LENGTH		MASS [kg]
		Lc [mm]	La [mm]	
C50	50	180	230	2
C100	100	230	330	2.3
C150	150	280	430	2.45
C200	200	330	530	2.6
C250	250	380	630	2.75
C300	300	430	730	2.9
C400	400	580	980	3.2

Length	Stroke ≤ 300 mm	Stroke > 300 mm
Lc [mm]	130 + Stroke	180 + Stroke
T [mm]	107 + Stroke	157 + Stroke

### PERFORMANCES AND FEATURES

- Pull-Push load up to 3 000 N
- Linear speed up to 41 mm/s
- Standard stroke lengths: 50, 100, 150, 200, 250, 300, 400 mm (min. stroke limited by FC switches: 50 mm) (for different / longer stroke lengths please contact us)
- Aluminium housing and rear attachment
- Chrome-plated steel push rod
- Stainless steel AISI 303 front attachment
- 12, 24 or 36 V DC motor with electromagnetic noise suppressor (motor features details on page 69)
- Duty cycle with max. load: 15% over 10 min at (-10 ... +40) °C
- Standard motor mounting position as per dimensional drawing (right-hand, code RH)
- Standard protection IP65
  - Test IP6X according to EN 60529 §12 §13.4-13.6
  - Test IPX5 according to EN 60529 §14.2.5 (tests made with not running actuator)
- Long-life lubrication, maintenance free

### ACCESSORIES

- Stainless steel push rod (code SS)
- Two adjustable built-in stroke end switches (code FC2)
- Two adjustable built-in stroke end switches, switching off the motor (code FC2X)
- Extra switch for intermediate position (code FC)
- 2-channels incremental encoder on motor shaft:
  - 1 ppr (code GI 21)
  - 4 ppr (code GI 24)
 (wiring diagrams on page 75)

Number of pulses for 100 mm stroke	Ratio			
	RN2	RN1	RL2	RL1
GI 21	246	492	775	1550
GI 24	984	1968	3100	6200

### OPTIONS

- Motor mounting position on opposite side (left-hand, code LH)
- Fixing attachment turned at 90° (code RPT 90)

### PERFORMANCES with 24 V DC motor

(Performances with 12 V DC motor: same load, linear speed 10 % less, electrical consumption 2 times more)

#### 1-start acme screw Tr 14x4

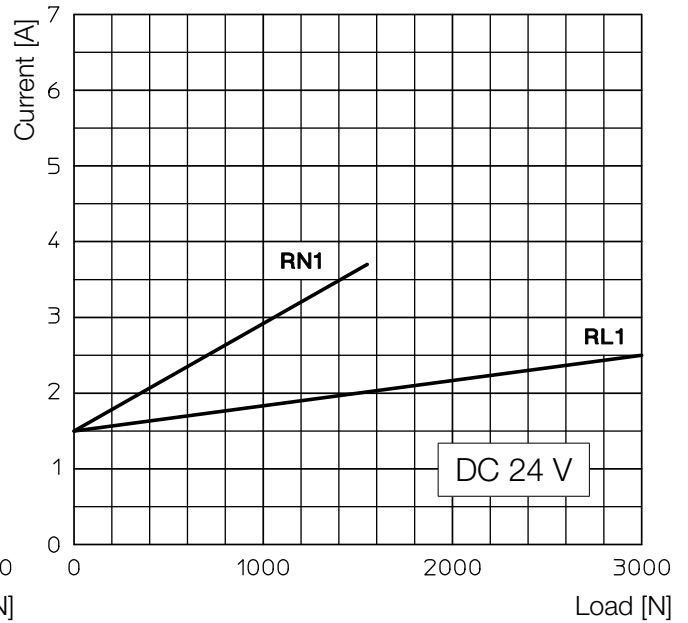
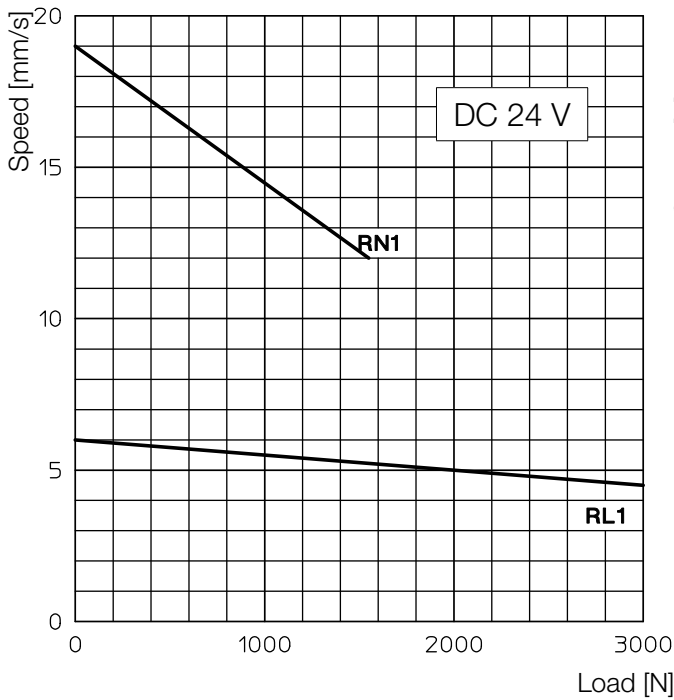

#### 2-starts acme screw Tr 14x8 (P4)

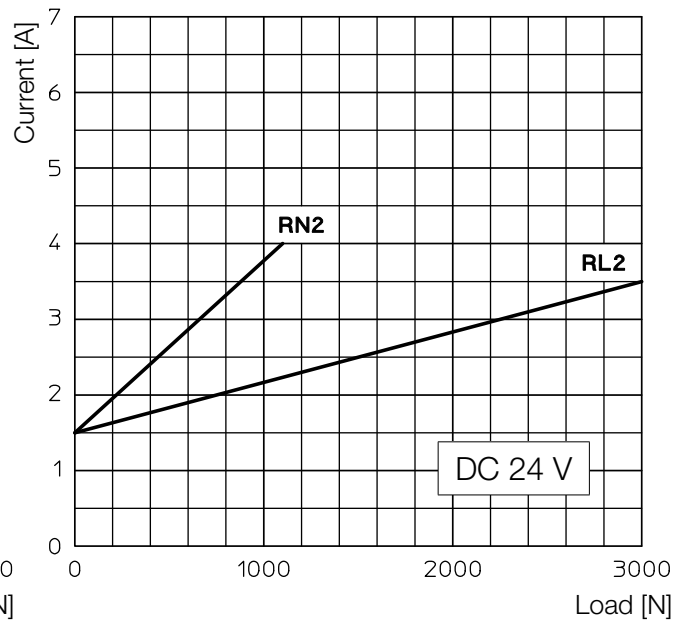
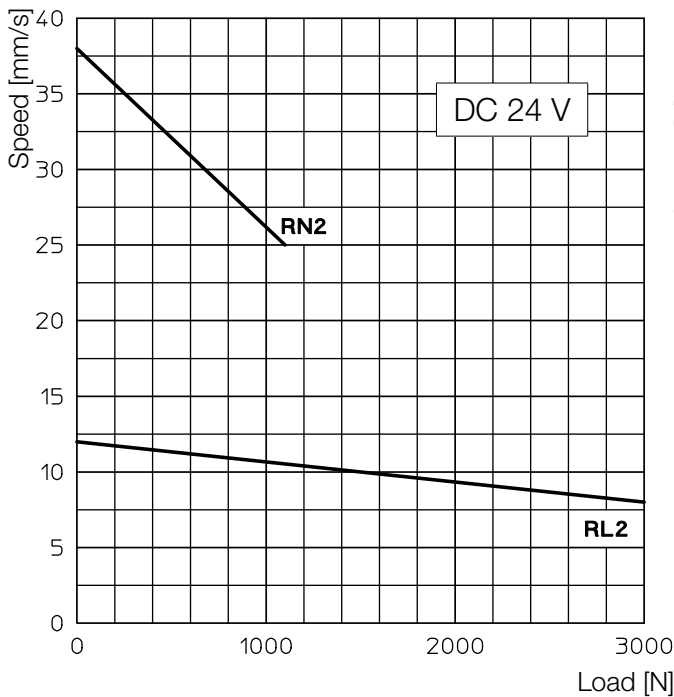

#### Self-locking conditions

Information about statically self-locking conditions with pull or push load on page 68.

#### ORDERING CODE EXAMPLE

LMR 02	RL1	C200	CC 24 V	FC2				
Actuator	Selected ratio	Required stroke	Motor	Stroke end switches	Accessories			Options

## 12. GENERAL FEATURES

### 12.3 DC MOTORS

#### Motors with interchangeable brushes (actuators ATL 10, UAL 0, BSA 10, BSA 11, UBA 0, CLB 25, CLB 27)

Permanent magnet DC motors, without fan, available with or without brake.

Long-life brushes, easy to replace.

Bipolar power supply cable 2 x 1 mm<sup>2</sup>, 1.5 m length. Motor weight: 1.3 kg.

Output power	70 W		Rated speed	3000 rpm	
Rated current	3.7 A (24 V)	8.4 A (12 V)	Rated torque	0.22 Nm	
Peak current	18 A (24 V)	30 A (12 V)	Peak torque	1.1 Nm	
Resistance	0.85 Ohm (24 V)	0.23 Ohm (12 V)	Inductance	1.34 mH (24 V)	0.36 mH (12 V)
Protection class	IP 54		Insulation class	F	

MOTOR BRAKE: Normally closed holding brake activated by DC electromagnet available on request.

Brake separately wired with bipolar cable 2 x 1 mm<sup>2</sup>, 1 m length.

Motor with brake total weight: 1.8 kg.

Power supply: 0.4 A a 24 V; 0.85 A a 12 V	Braking torque: 0.5 Nm
---	------------------------

**WARNING! The motor brake is normally closed; to open it, a constant rated voltage power supply is required. With lower voltage, the brake does not open.**

#### Motors with non-interchangeable brushes (linear actuators LMR, ATL, CLA, LMP, LMI Series)

Permanent magnet DC motors, without fan.

The brake is not available; the brushes are not interchangeable.

Standard motors winding has insulation class B.

These motors have open enclosures: the actuator is fitted with proper motor outer protections which allow to reach motor Protection Class IP 65.

The performance diagrams concerning actuators with DC motor stated in this catalogue, show the input power variation depending on the load variation.

This allows to select power supply / drivers properly.

#### Motor wires connection – Actuator push rod travelling direction

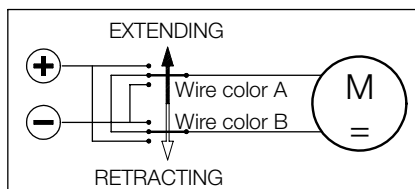

Actuator with DC motor, RIGHT-HAND mounting	LMR 01	LMR 03	ATL 02	ATL 05	ATL 08	ATL 12	CLA 20	CLA 25
Wire color A	red	red	brown	brown	brown	red	brown	brown
Wire color B	black	black	blue	blue	blue	blue	blue	blue

Actuator with DC motor, LEFT-HAND mounting	LMR 01	LMR 03	ATL 02	ATL 05	ATL 08	ATL 12	CLA 20	CLA 25
Wire color A	red	red	blue	blue	blue	blue	blue	blue
Wire color B	black	brown	brown	brown	brown	red	brown	brown

## 13.3 Electric stroke end switches FC (linear actuators LMR Series)

Each of the two micro-switches is fitted in a slot with a cam for switches commutation. A screw allows to lock the assembly in the desired position, adjusting in this way the switching position. The nut with suitable shape makes the cams rotate, so to activate the switches. This cam-operated device provides a stable and self-keeping commutation of the switches. The **MIN. RETRACTED LENGTH  $L_c$**  of the actuator is adjusted and controlled by switch FC1. The **MAX. EXTENDED LENGTH  $L_a$**  of the actuator is adjusted and controlled by switch FC2.

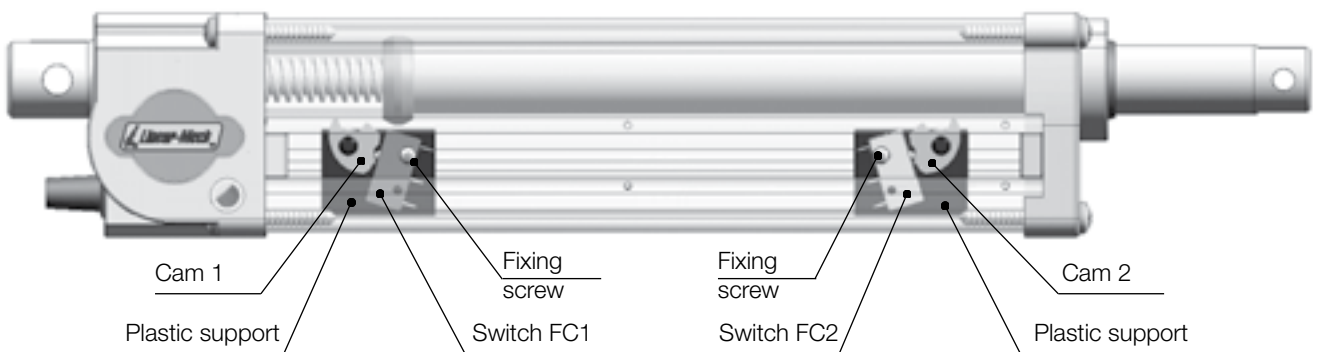

Following pictures show the switching sequence for switch FC2.

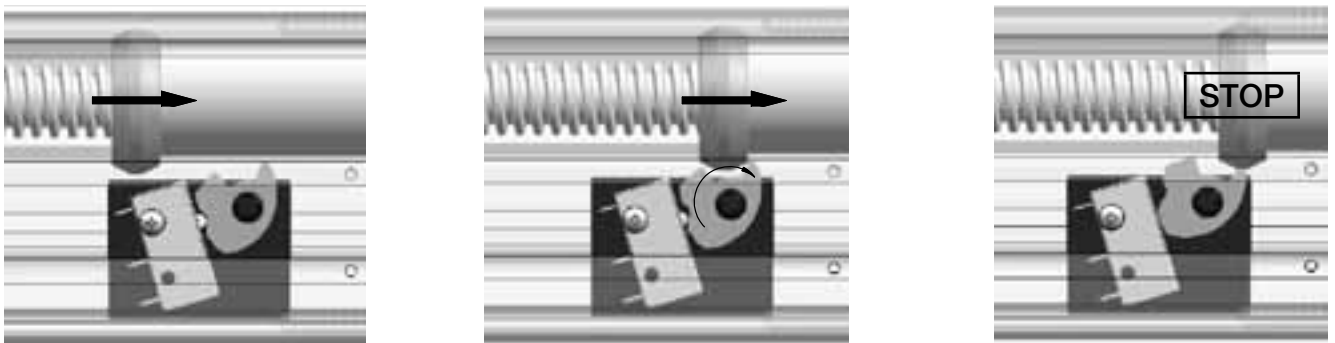

Standard switches have silver-plated contacts, max. current 12 A with resistive load - 6 A with inductive load. Switches with gold-plated contacts, very low contact resistance for low working voltage (if connected to PLC or PC), max. current 0.1 A, available on request.

### STANDARD switch connection

Code **FC2**: two electric cam-operated switches, wired on contact NC (to be connected into the external control circuit). On request, the switches can be wired on the contact NO or on switch-over contact CS. Code **FC2X**: two electric cam-operated switches, internally wired between power supply and electric motor, in order to switch off the power supply directly, without relays.

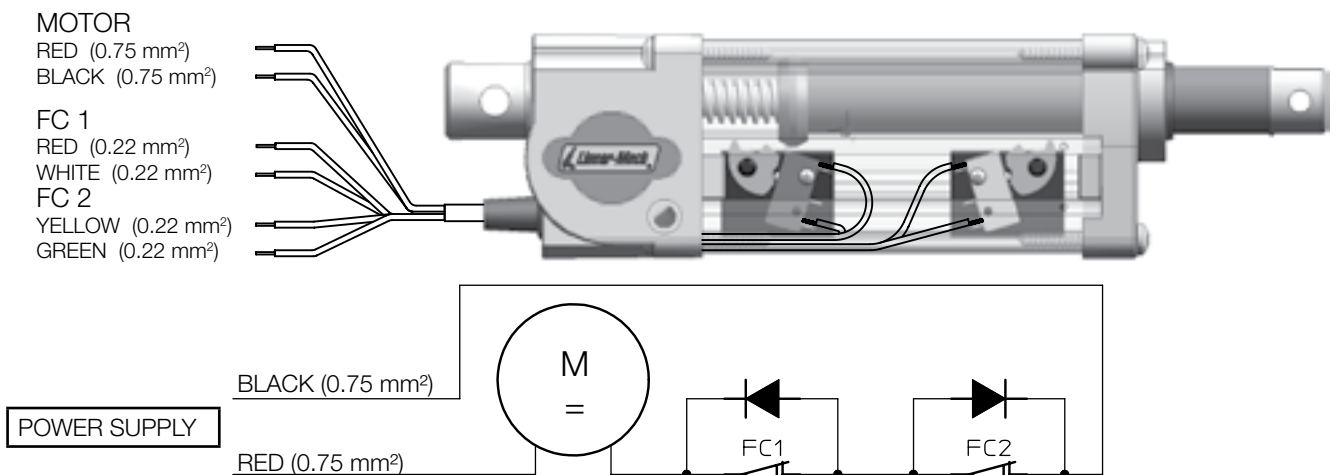

## 13.5 Encoder GI (linear actuators LMR 01, LMR02, LMR 03 and LMP03)

Hall effect, bi-directional, incremental encoder

Output configuration: PUSH-PULL

Code GI 21: 2 output channels, 1 pulse per revolution

Code GI 24: 2 output channels, 4 pulses per revolution

Cable length: as motor cable

Protected against polarity inversion

Protected against any incorrect output connection

NOTE: For conductive cables colour, please refer to the wiring diagram in the “Installation Instructions” supplied with the product.

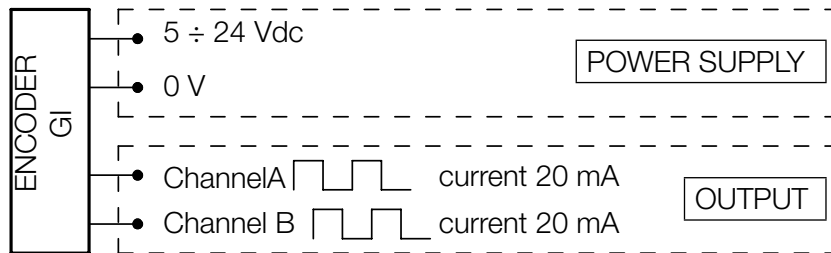

## 13.6 Encoder EH38 (linear actuators ATL 10, UAL 0, BSA 10, UBA 0)

Bi-directional, incremental, optical encoder

Output configuration: PUSH-PULL

Code EH38: 2 output channels, 100 pulses per revolution, with zero set pulse

Cable length: 1.3 m

Protected against short circuit

Protected against polarity inversion

Protected against any incorrect output connection

Input voltage: 8÷24 Vcc

No load power consumption: 100 mA

Max. commutable current: 50 mA per channel

NOTE: Safety clutch FS cannot be used with rotative encoder (the position reference would be lost due to its slipping).

